

TITAN

PI 245HC B - PI 235HC B

MONDOLFO FERRO

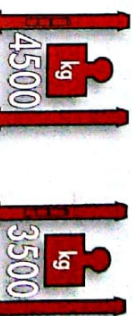

Sollevatori elettroidraulici a due colonne.
Fiallineamento dei due carrelli tramite funi metalliche che garantiscono un'ottima sincronizzazione dei carrelli.
Bracci asimmetrici a tre stadi.

Electro-hydraulic two post lifts.
Realignment of the two carriages using metal cables that guarantee excellent synchronisation.
Three-stages asymmetrical lifting arms.

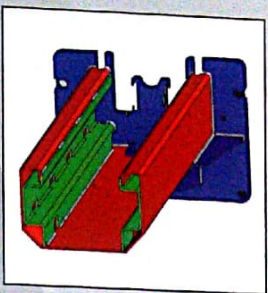

1. Struttura colonna rinforzata internamente.
Internally reinforced column structure.

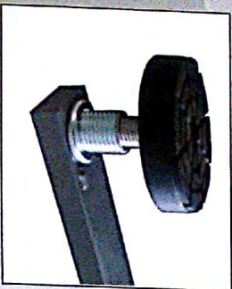

2. Doppia filettatura per una grande regolazione verticale del tampone (95÷180 mm).
Double threaded to ensure excellent vertical adjustment (95÷180 mm).

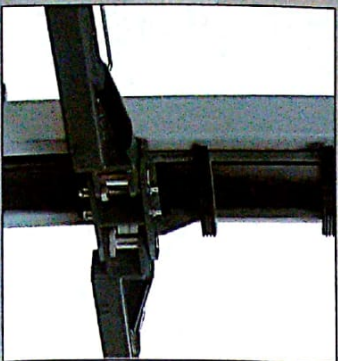

3. Arresto rotazione bracci a settori dentati
Toothed sector arm rotation stop system.
4. Protezioni in gomma salvaportiera.
Rubber door protections.

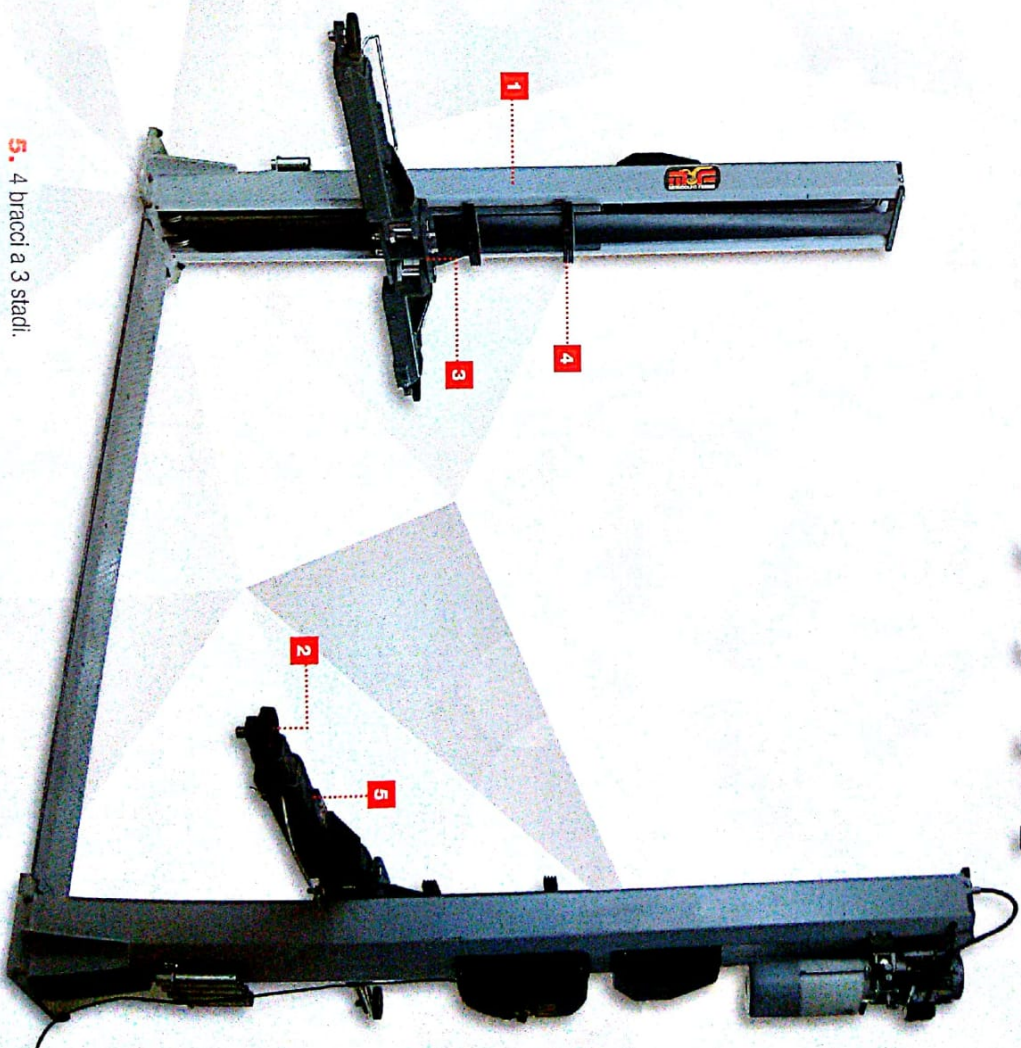

5. 4 bracci a 3 stadi.
4 three-section support arms.

TITAN PI 245HC B - PI 235HC B

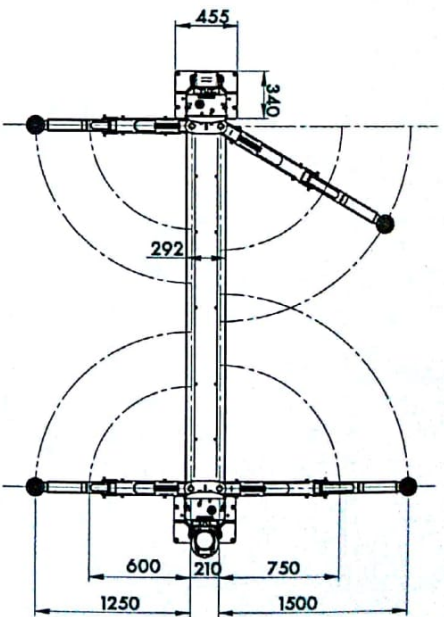
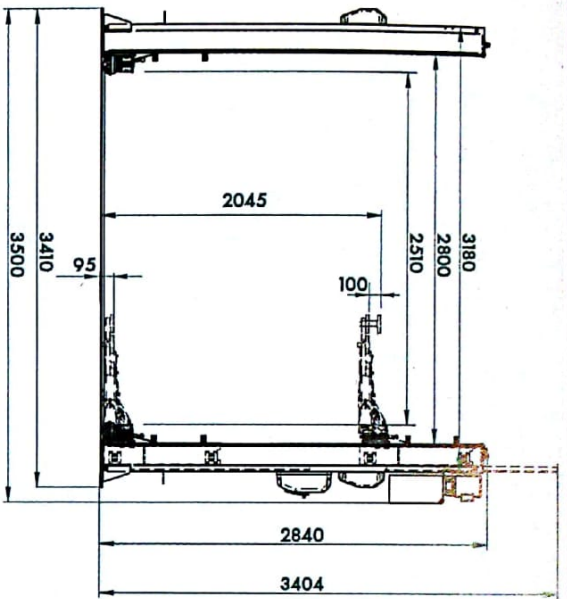

Accessori a richiesta Optional accessories

- ✓ Set tasselli di fissaggio al suolo (obbligatorio)
- ✓ Pompa manuale di emergenza
- ✓ Basamento portante.
- ✓ Set of masonry bolts (compulsory).
- ✓ Emergency hand pump.
- ✓ Load-bearing base frame.

Tutti modelli completi di All models supplied with:

- ✓ Dispositivo di appoggio meccanico dei carrelli su ogni colonna garantisce la massima sicurezza di lavoro.
- ✓ Due set di prolunghie tamponi.
- ✓ Mechanical carriage support device on each column ensures optimum working safety.
- ✓ Two set of extension pads.

Dati tecnici Technical data

TTTAN

	PI 245HC B	PI 235HC B
Portata sollevatore	4500 kg	3500 kg
Tempo di salita	40 s	40 s
Motore	400/230V-3kW-3ph-50 Hz	400/230V-3kW-3ph-50 Hz
Altezza max. sollevatore	1945 mm	1945 mm
Altezza minima sollevatore	95 mm	95 mm
	Lift capacity	Lift capacity
	Lifting time	Lifting time
	Motor	Motor
	Lift max. lifting height	Lift max. lifting height
	Lift minimum height	Lift minimum height